

Very low drop voltage regulators with inhibit

Features

- Very low dropout voltage (0.2 V typ. at 50 mA load)
- Very low quiescent current (typ. 500 μ A at 50 mA load)
- Output current up to 50 mA
- Logic-controlled electronic shutdown
- Output voltages of 3.0; 3.3; 3.8; 5.0 V
- Internal current and thermal limit
- Supply voltage rejection: 63 dB (typ)
- Only 1 μ F for stability
- Selection at 25 °C
- Temperature range: -25 °C to 125 °C
- Package available: SOT23-5L



Description

The LD2979 series are very low drop regulators available in SOT23-5L.

The very low drop-voltage and the very low quiescent current make them particularly suitable for low noise, low power applications and in battery powered systems.

Shutdown logic control function is available on five pin version (TTL compatible). This means that

when the device is used as local regulator, it is possible to put a part of the board in standby, decreasing the total power consumption.

Table 1. Device summary

Part numbers	Order codes	Output voltages
LD2979XX30	LD2979M30TR	3.0 V
LD2979XX33	LD2979M33TR	3.3 V
LD2979XX38	LD2979M38TR	3.8 V
LD2979XX50	LD2979M50TR	5.0 V

Contents

1	Diagram	3
2	Pin configuration	4
3	Maximum ratings	5
4	Electrical characteristics	6
5	Typical characteristics	8
6	Package mechanical data	11
7	Revision history	14

1 Diagram

Figure 1. Schematic diagram

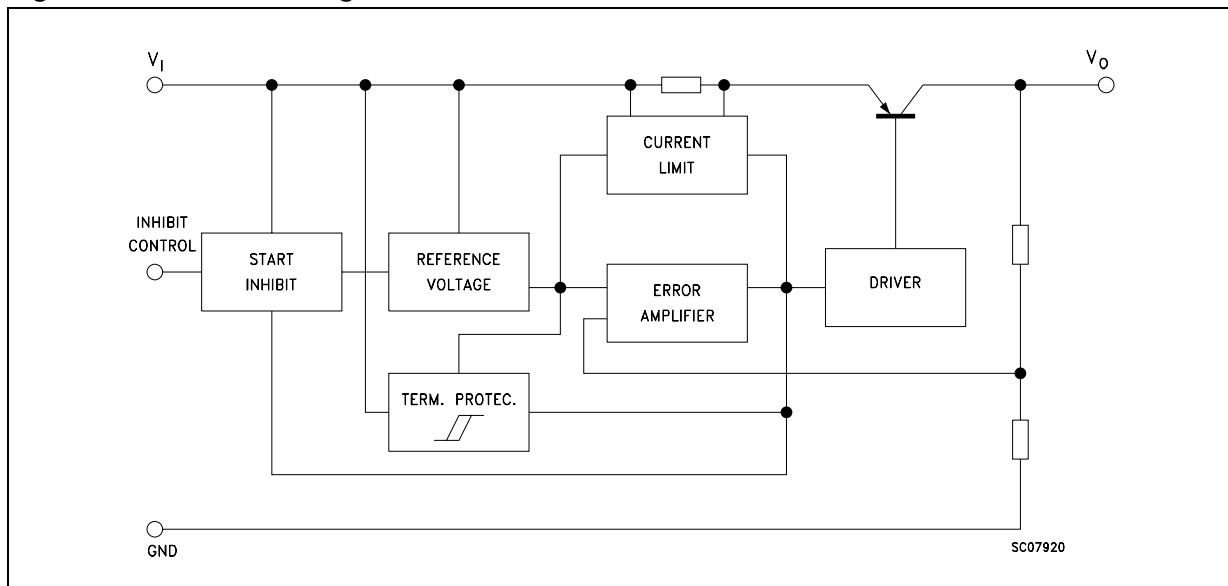

2 Pin configuration

Figure 2. Pin connections (top view)

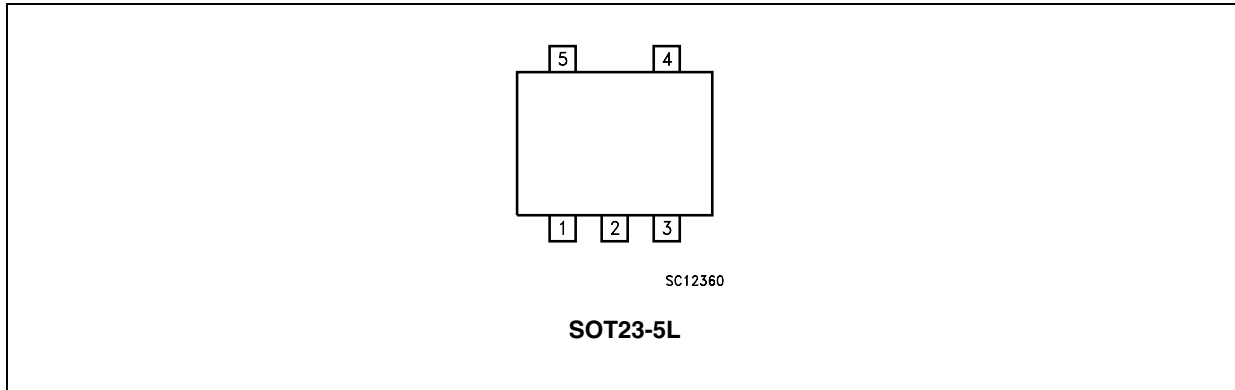

Table 2. Pin description

Symbol	Name and function	Pin number
V_I	Input voltage	1
GND	Ground	2
INHIBIT	Control switch ON/OFF ⁽¹⁾	3
NC	Not to be connected	4
V_O	Output voltage	5

1. Inhibit pin is not internally pulled-up then it must not be left floating. Connect to a positive voltage higher than 2 V to able the device.

3 Maximum ratings

Table 3. Absolute maximum ratings

Symbol	Parameter	Value	Unit
V_I	DC input voltage	16	V
V_{INH}	DC inhibit input voltage	V_{IN}	V
I_O	Output current	Internally limited	
P_D	Power dissipation	Internally limited	
T_{STG}	Storage temperature range	-40 to 150	°C
T_{OP}	Operating junction temperature range	-25 to 125	°C

Note: Absolute maximum ratings are those values beyond which damage to the device may occur. Functional operation under these condition is not implied.

4 Electrical characteristics

Table 4. Electrical characteristics for LD2979xx (refer to the test circuits, $T_a = 25\text{ }^\circ\text{C}$, $V_{IN} = V_{O(NOM)} + 1\text{ V}$, $I_O = 1\text{ mA}$, $V_{INH} = 2\text{ V}$, $C_O = 1\text{ }\mu\text{F}$, unless otherwise specified).

Symbol	Parameter	Test conditions	Min.	Typ.	Max.	Unit
V_O	Output voltage	$V_{IN} = 3.85\text{ V}$	2.793	2.85	2.907	V
		$I_O = 1\text{ to }50\text{ mA}$, $T_a = -25\text{ to }125\text{ }^\circ\text{C}$	2.736		2.964	
V_O	Output voltage	$V_{IN} = 4\text{ V}$	2.940	3	3.060	V
		$I_O = 1\text{ to }50\text{ mA}$, $T_a = -25\text{ to }125\text{ }^\circ\text{C}$	2.880		3.120	
V_O	Output voltage	$V_{IN} = 4.3\text{ V}$	3.234	3.3	3.366	V
		$I_O = 1\text{ to }50\text{ mA}$, $T_a = -25\text{ to }125\text{ }^\circ\text{C}$	3.168		3.432	
V_O	Output voltage	$V_{IN} = 4.8\text{ V}$	3.724	3.8	3.876	V
		$I_O = 1\text{ to }50\text{ mA}$, $T_a = -25\text{ to }125\text{ }^\circ\text{C}$	3.648		3.952	
V_O	Output voltage	$V_{IN} = 6\text{ V}$	4.9	5	5.1	V
		$I_O = 1\text{ to }50\text{ mA}$, $T_a = -25\text{ to }125\text{ }^\circ\text{C}$	4.8		5.2	
I_O	Output current limit		100			mA
ΔV_O	Line regulation	$V_{IN} = V_{O(NOM)} + 1\text{ V to }16\text{ V}$, $I_O = 1\text{ mA}$			0.028	%/ V_{IN}
		$T_a = -25\text{ to }125\text{ }^\circ\text{C}$			0.064	
I_d	Quiescent current (On Mode)	$I_O = 0$		80	110	μA
		$I_O = 0$, $T_a = -25\text{ to }125\text{ }^\circ\text{C}$			170	
		$I_O = 50\text{ mA}$		500	700	
		$I_O = 50\text{ mA}$, $T_a = -25\text{ to }125\text{ }^\circ\text{C}$			1300	
	Quiescent current (Off Mode)	$V_{INH} < 0.18\text{ V}$		0		μA
		$V_{INH} < 0.18\text{ V}$, $T_a = -25\text{ to }125\text{ }^\circ\text{C}$			1	
SVR	Supply voltage rejection	$I_O = 50\text{ mA}$, $C_{OUT} = 10\text{ }\mu\text{F}$, $f = 120\text{ Hz}$		63		dB
V_d	Dropout voltage	$I_O = 0$		6	12	mV
		$I_O = 0$, $T_a = -25\text{ to }125\text{ }^\circ\text{C}$			18	
		$I_O = 1\text{ mA}$		30	60	
		$I_O = 1\text{ mA}$, $T_a = -25\text{ to }125\text{ }^\circ\text{C}$			90	
		$I_O = 10\text{ mA}$		100	200	
		$I_O = 10\text{ mA}$, $T_a = -25\text{ to }125\text{ }^\circ\text{C}$			300	
		$I_O = 50\text{ mA}$		200	400	
		$I_O = 50\text{ mA}$, $T_a = -25\text{ to }125\text{ }^\circ\text{C}$			600	
V_{IL}	Inhibit input logic low	Device Off, $T_a = -25\text{ to }125\text{ }^\circ\text{C}$			0.18	V
V_{IH}	Inhibit input logic high	Device On, $T_a = -25\text{ to }125\text{ }^\circ\text{C}$	2			V

Table 4. Electrical characteristics for LD2979xx (continued) (refer to the test circuits, $T_a = 25\text{ }^\circ\text{C}$, $V_{IN} = V_{O(NOM)} + 1\text{ V}$, $I_O = 1\text{ mA}$, $V_{INH} = 2\text{ V}$, $C_O = 1\text{ }\mu\text{F}$, unless otherwise specified).

Symbol	Parameter	Test conditions	Min.	Typ.	Max.	Unit
I_I	Inhibit input current	$V_{INH} = 0\text{ V}$		0	-1	μA
		$V_{INH} = 5\text{ V}$, $T_a = -25\text{ to }125\text{ }^\circ\text{C}$		5	15	
eN	Output noise voltage (RMS)	BW= 300Hz to 50kHz, $C_O = 10\mu\text{F}$		160		μV

5 Typical characteristics

(unless otherwise specified $T_A = 25\text{ }^\circ\text{C}$)

Figure 3. Output voltage vs temperature

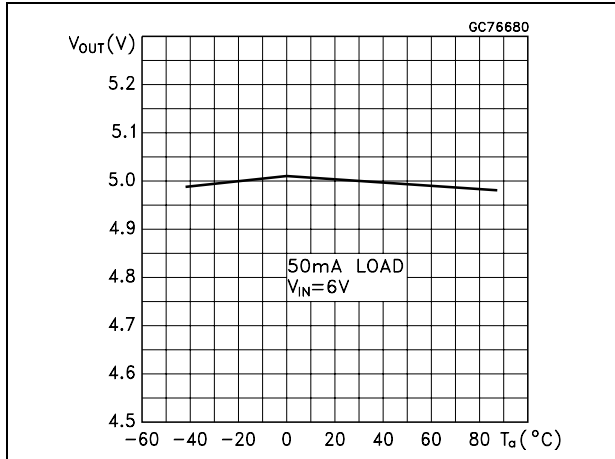

Figure 4. Output voltage vs input voltage

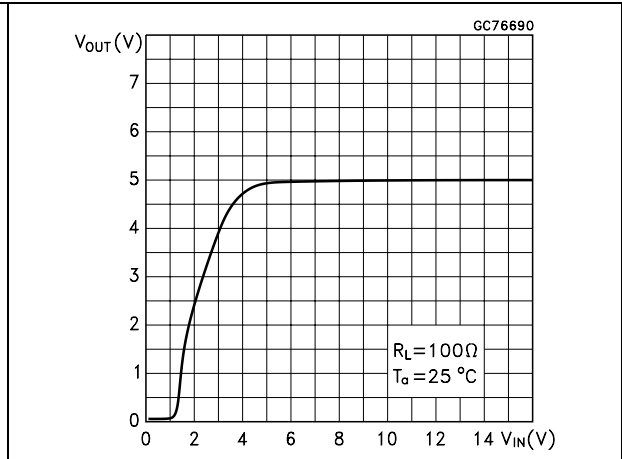

Figure 5. Output voltage vs input voltage

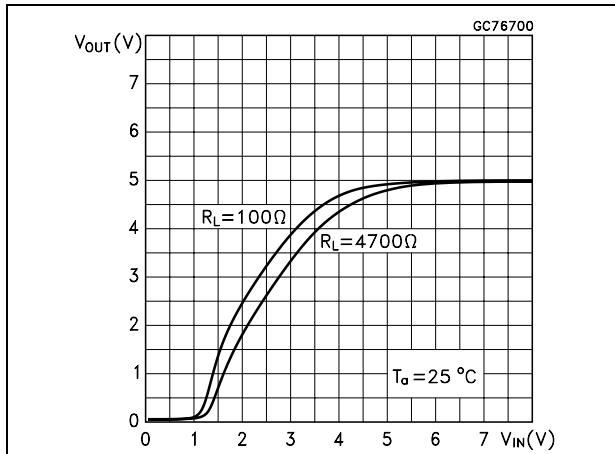

Figure 6. Dropout voltage vs output current

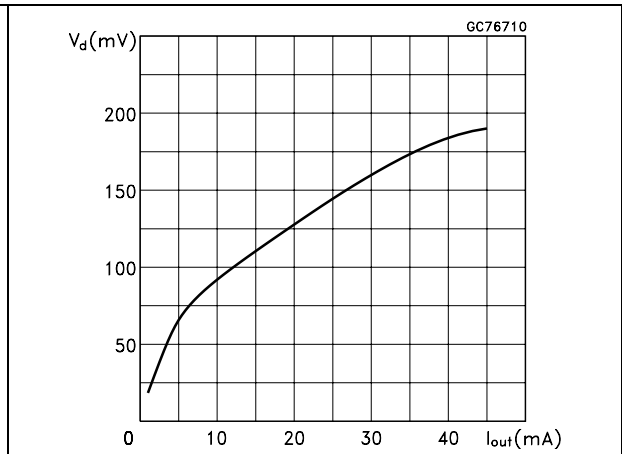

Figure 7. Dropout voltage vs temperature

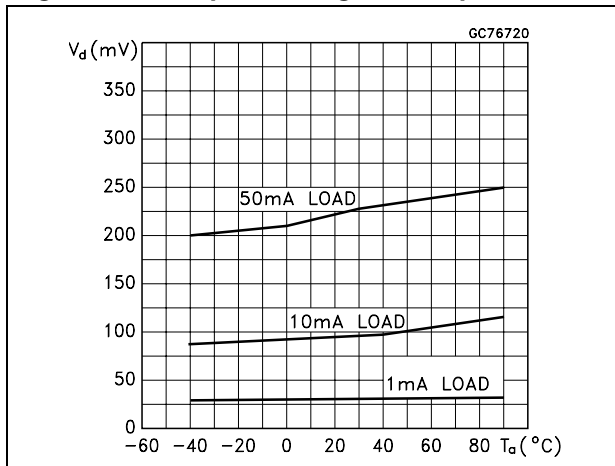

Figure 8. Quiescent current vs temperature

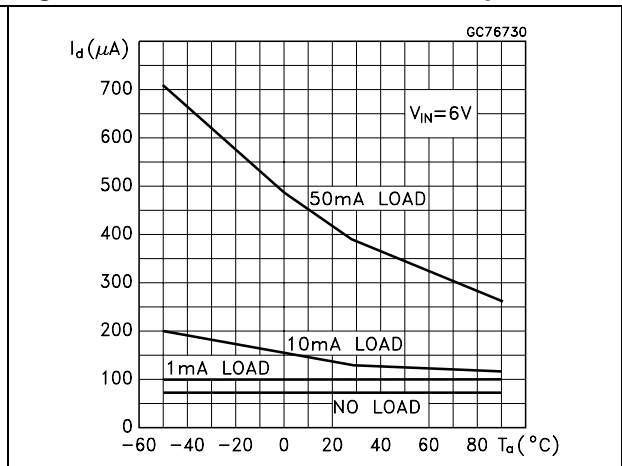

Figure 9. Short circuit current vs dropout voltage

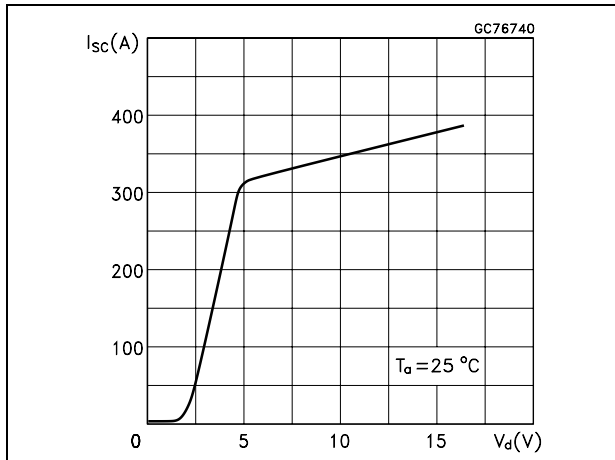

Figure 10. Inhibit voltage vs temperature

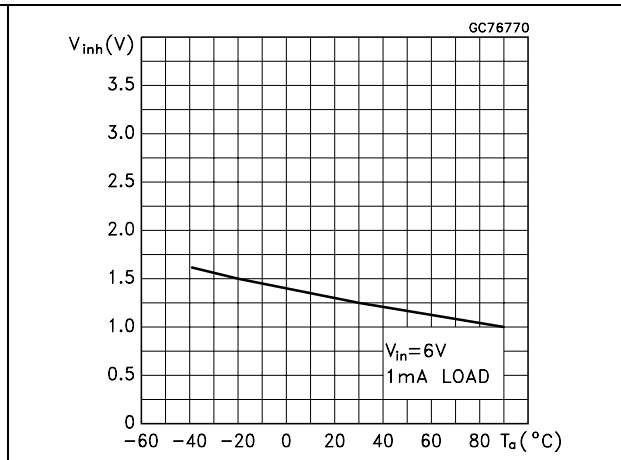

Figure 11. Supply voltage rejection vs frequency

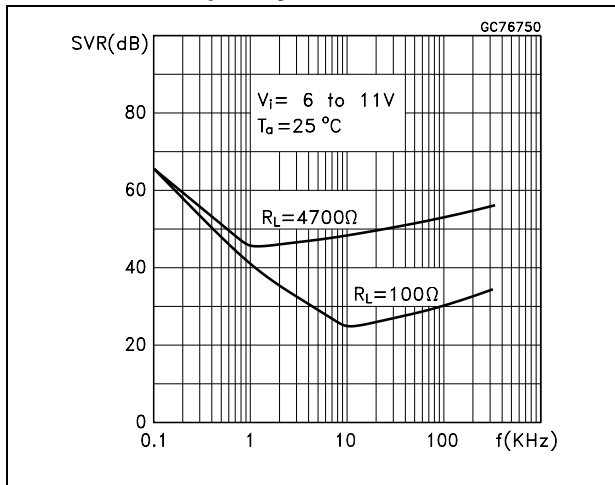

Figure 12. Load transient response

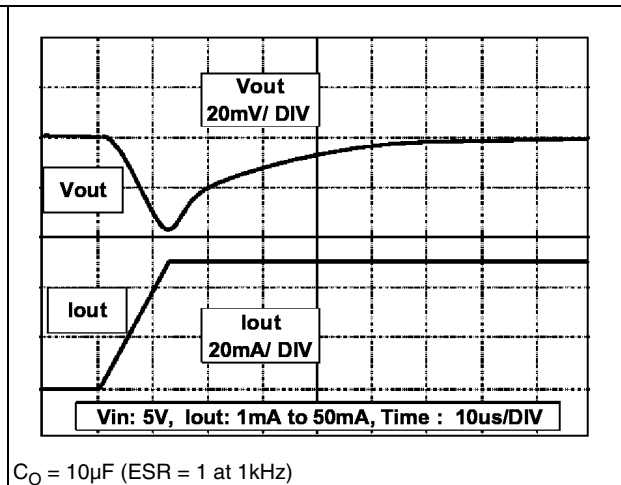

Figure 13. Inhibit current vs temperature

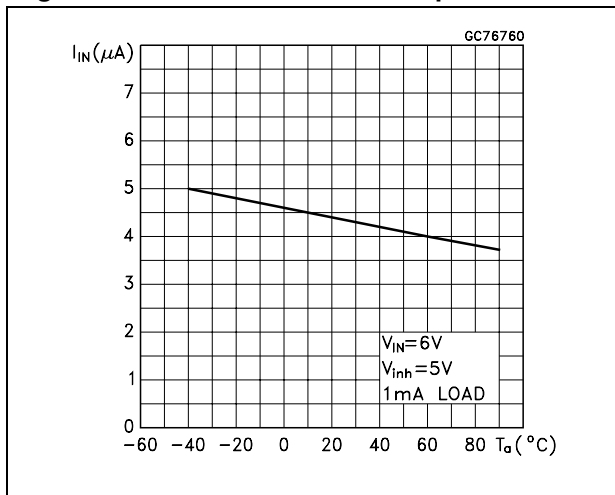

Figure 14. Load transient response

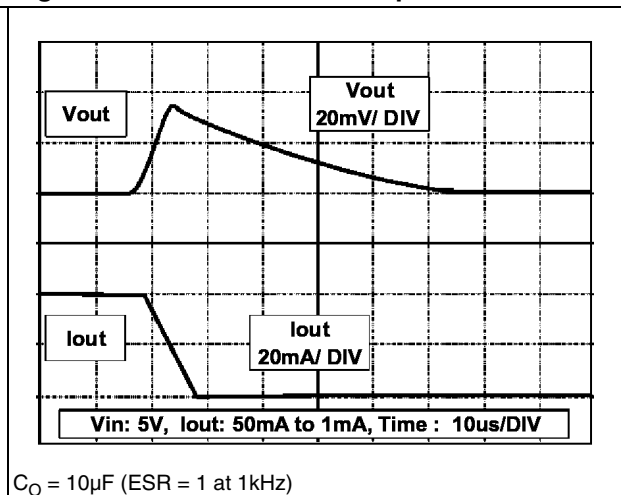
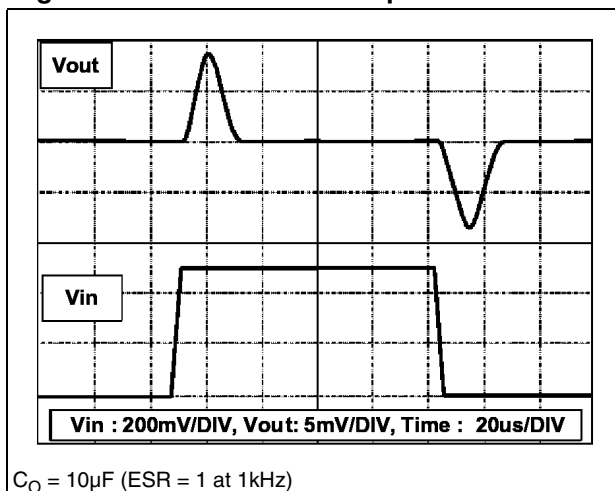

Figure 15. Line transient response



6 Package mechanical data

In order to meet environmental requirements, ST offers these devices in ECOPACK® packages. These packages have a lead-free second level interconnect. The category of second Level Interconnect is marked on the package and on the inner box label, in compliance with JEDEC Standard JESD97. The maximum ratings related to soldering conditions are also marked on the inner box label. ECOPACK is an ST trademark. ECOPACK specifications are available at: www.st.com.

SOT23-5L mechanical data

Dim.	mm.			mils.		
	Min.	Typ.	Max.	Min.	Typ.	Max.
A	0.90		1.45	35.4		57.1
A1	0.00		0.10	0.0		3.9
A2	0.90		1.30	35.4		51.2
b	0.35		0.50	13.7		19.7
C	0.09		0.20	3.5		7.8
D	2.80		3.00	110.2		118.1
E	1.50		1.75	59.0		68.8
e		0.95			37.4	
H	2.60		3.00	102.3		118.1
L	0.10		0.60	3.9		23.6

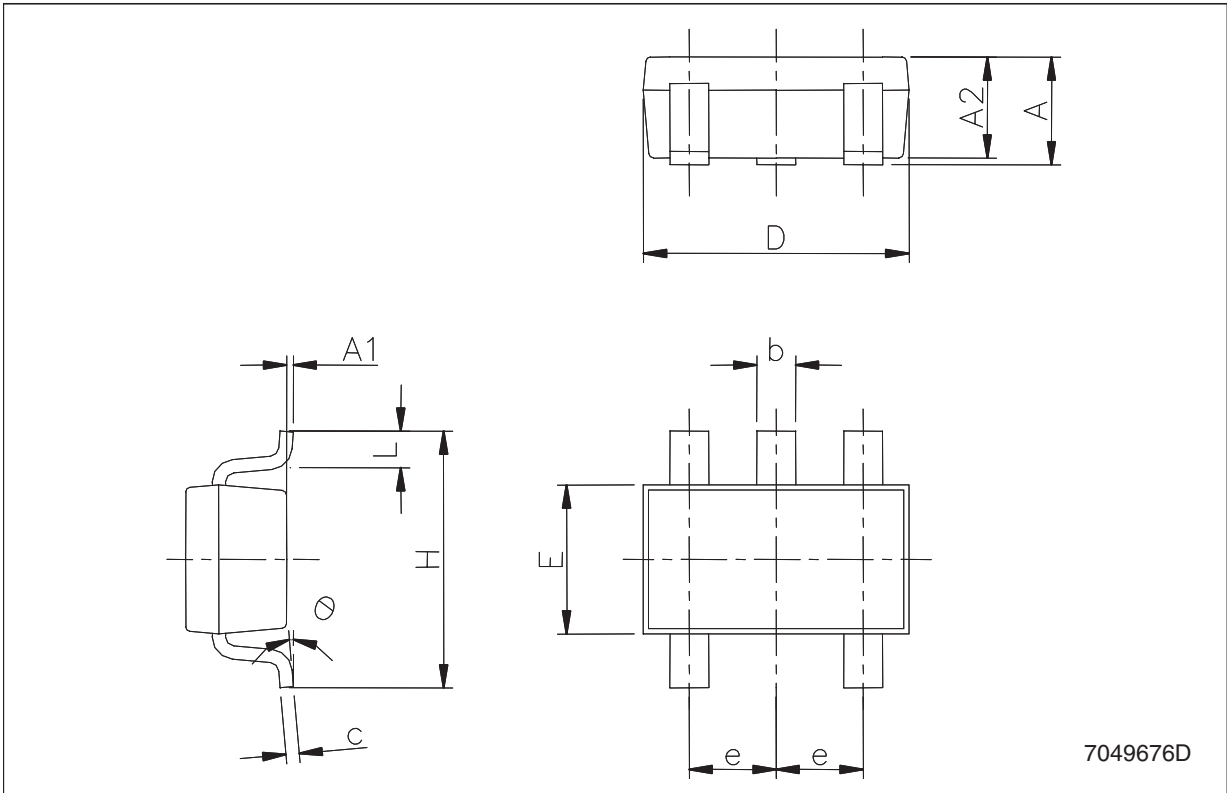

Tape & reel SOT23-xL mechanical data

Dim.	mm.			inch.		
	Min.	Typ.	Max.	Min.	Typ.	Max.
A			180			7.086
C	12.8	13.0	13.2	0.504	0.512	0.519
D	20.2			0.795		
N	60			2.362		
T			14.4			0.567
Ao	3.13	3.23	3.33	0.123	0.127	0.131
Bo	3.07	3.17	3.27	0.120	0.124	0.128
Ko	1.27	1.37	1.47	0.050	0.054	0.058
Po	3.9	4.0	4.1	0.153	0.157	0.161
P	3.9	4.0	4.1	0.153	0.157 <td 0.161	

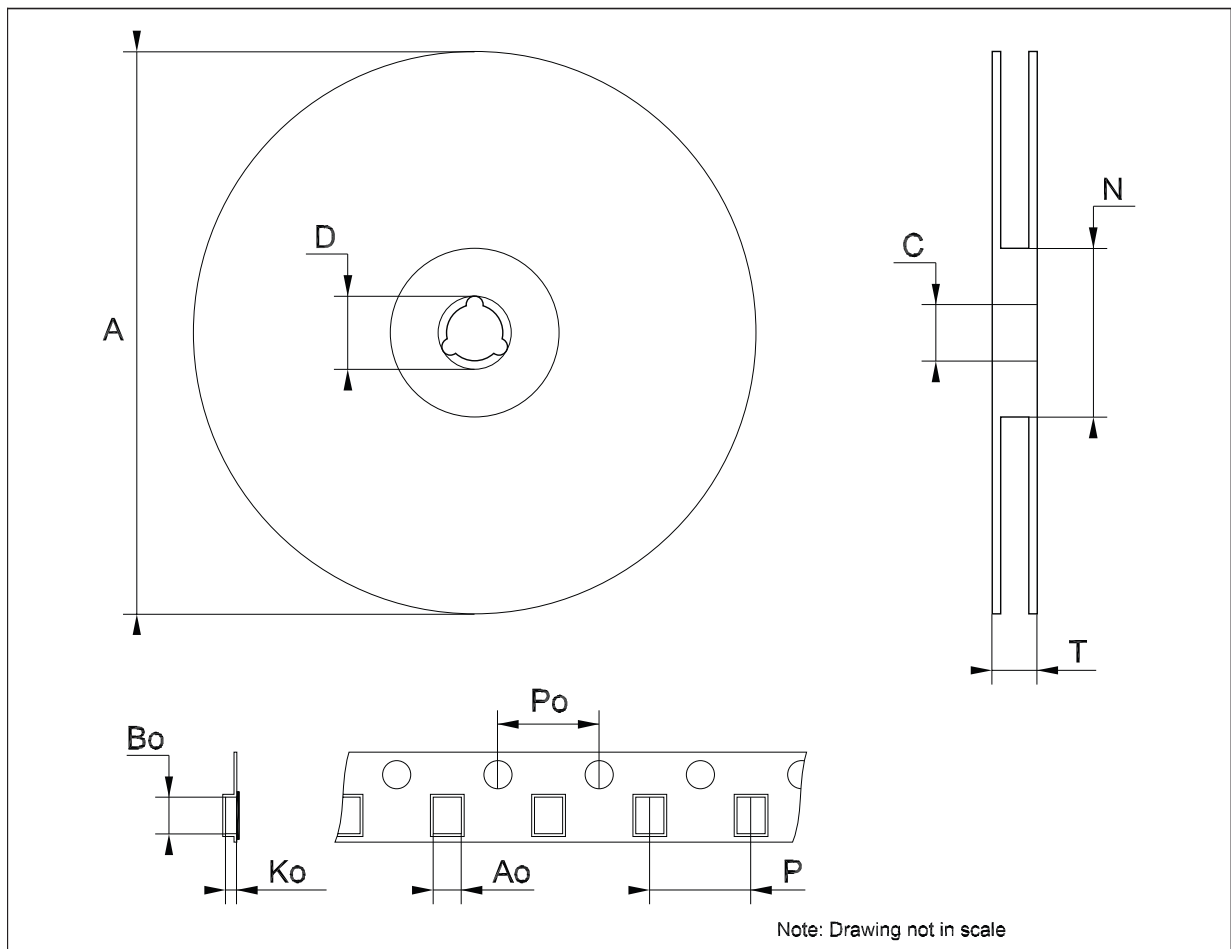

7 Revision history

Table 5. Document revision history

Date	Revision	Changes
15-Mar-2005	10	Add tape & reel for TO-92.
03-Jul-2006	11	Order codes updated.
16-May-2007	12	Order codes updated.
08-Jun-2007	13	Order codes updated.
09-Apr-2008	14	Modified: Table 1 on page 1 .

Please Read Carefully:

Information in this document is provided solely in connection with ST products. STMicroelectronics NV and its subsidiaries ("ST") reserve the right to make changes, corrections, modifications or improvements, to this document, and the products and services described herein at any time, without notice.

All ST products are sold pursuant to ST's terms and conditions of sale.

Purchasers are solely responsible for the choice, selection and use of the ST products and services described herein, and ST assumes no liability whatsoever relating to the choice, selection or use of the ST products and services described herein.

No license, express or implied, by estoppel or otherwise, to any intellectual property rights is granted under this document. If any part of this document refers to any third party products or services it shall not be deemed a license grant by ST for the use of such third party products or services, or any intellectual property contained therein or considered as a warranty covering the use in any manner whatsoever of such third party products or services or any intellectual property contained therein.

UNLESS OTHERWISE SET FORTH IN ST'S TERMS AND CONDITIONS OF SALE ST DISCLAIMS ANY EXPRESS OR IMPLIED WARRANTY WITH RESPECT TO THE USE AND/OR SALE OF ST PRODUCTS INCLUDING WITHOUT LIMITATION IMPLIED WARRANTIES OF MERCHANTABILITY, FITNESS FOR A PARTICULAR PURPOSE (AND THEIR EQUIVALENTS UNDER THE LAWS OF ANY JURISDICTION), OR INFRINGEMENT OF ANY PATENT, COPYRIGHT OR OTHER INTELLECTUAL PROPERTY RIGHT.

UNLESS EXPRESSLY APPROVED IN WRITING BY AN AUTHORIZED ST REPRESENTATIVE, ST PRODUCTS ARE NOT RECOMMENDED, AUTHORIZED OR WARRANTED FOR USE IN MILITARY, AIR CRAFT, SPACE, LIFE SAVING, OR LIFE SUSTAINING APPLICATIONS, NOR IN PRODUCTS OR SYSTEMS WHERE FAILURE OR MALFUNCTION MAY RESULT IN PERSONAL INJURY, DEATH, OR SEVERE PROPERTY OR ENVIRONMENTAL DAMAGE. ST PRODUCTS WHICH ARE NOT SPECIFIED AS "AUTOMOTIVE GRADE" MAY ONLY BE USED IN AUTOMOTIVE APPLICATIONS AT USER'S OWN RISK.

Resale of ST products with provisions different from the statements and/or technical features set forth in this document shall immediately void any warranty granted by ST for the ST product or service described herein and shall not create or extend in any manner whatsoever, any liability of ST.

ST and the ST logo are trademarks or registered trademarks of ST in various countries.

Information in this document supersedes and replaces all information previously supplied.

The ST logo is a registered trademark of STMicroelectronics. All other names are the property of their respective owners.

© 2008 STMicroelectronics - All rights reserved

STMicroelectronics group of companies

Australia - Belgium - Brazil - Canada - China - Czech Republic - Finland - France - Germany - Hong Kong - India - Israel - Italy - Japan - Malaysia - Malta - Morocco - Singapore - Spain - Sweden - Switzerland - United Kingdom - United States of America

www.st.com